

Data Sheet



Article number: 12621000140700

Description: Threaded pin 621 000 140.700
For M14

Measures

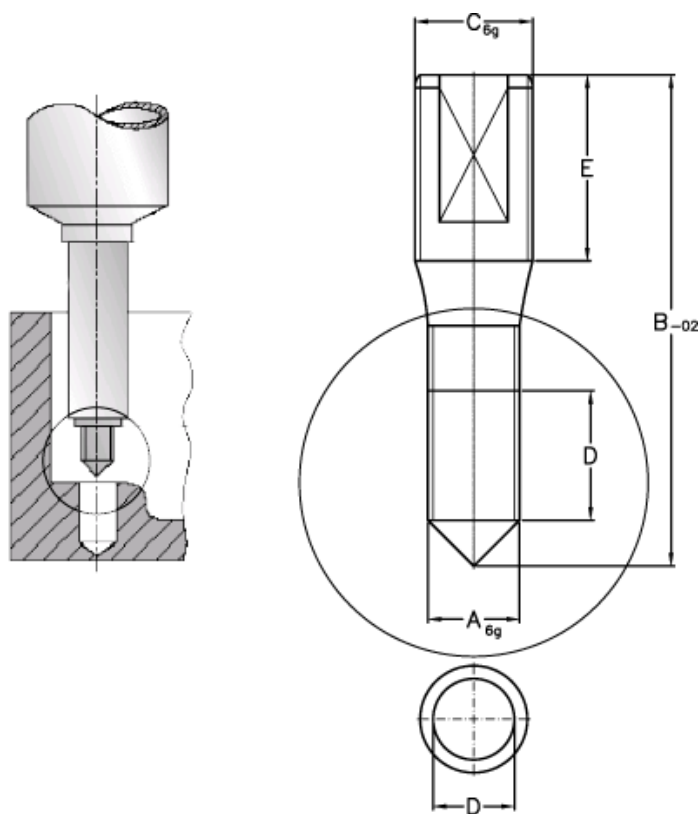

A = M14
B = 141.5
C = M18
D = 28.0
E = 32